

114.00

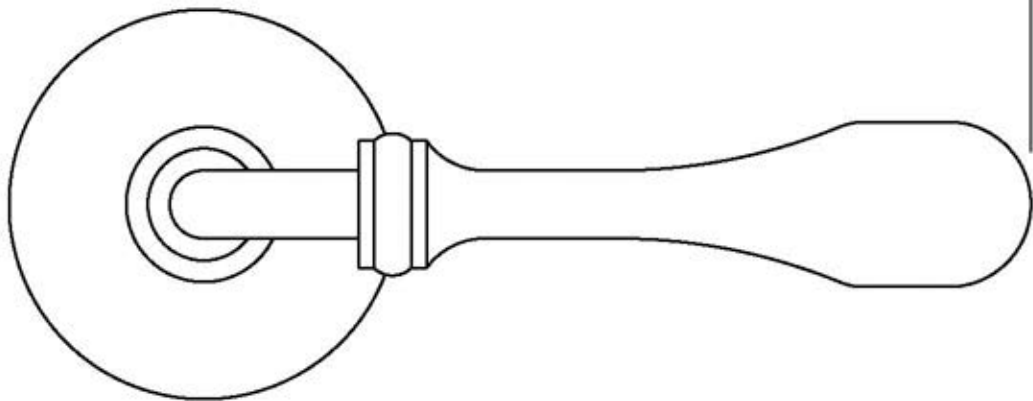

66.40

